

MUÑECO DE NIEVE

BONHOMME DE NEIGE

SNOWMAN

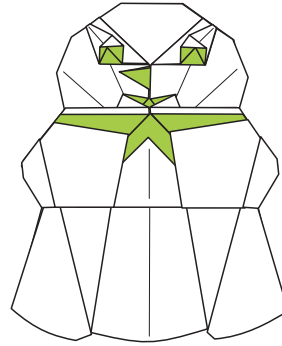

Román Díaz

<http://www.passionorigami.com>

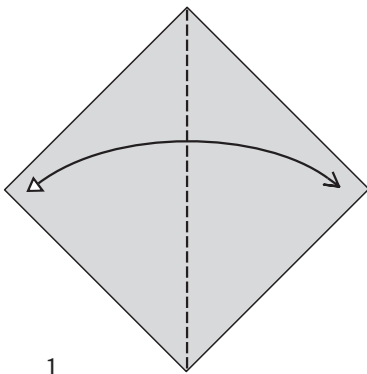

1.

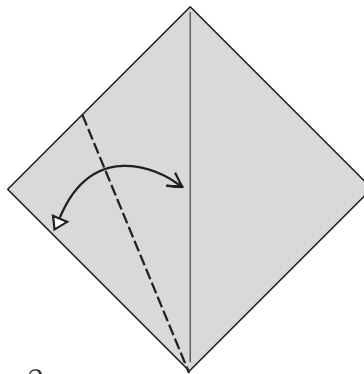

2.

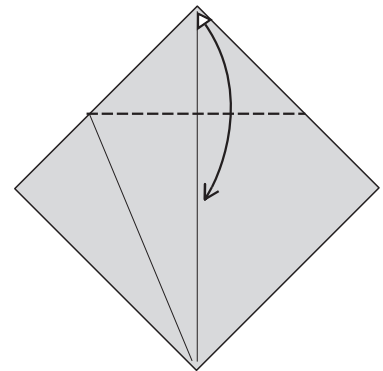

3.

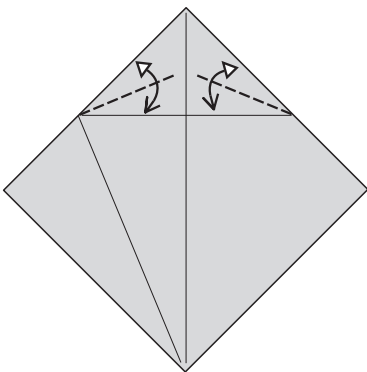

4.

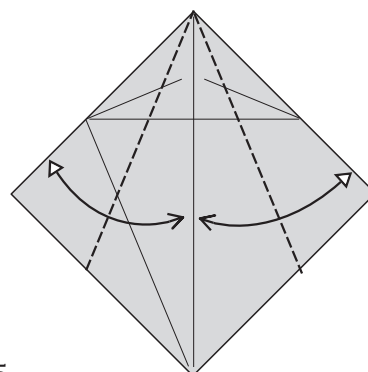

5.

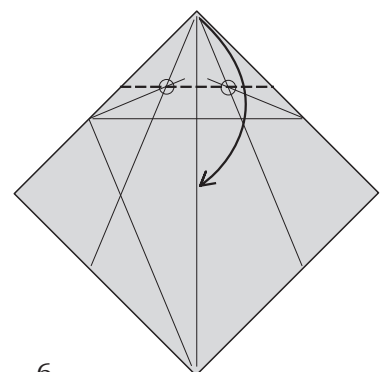

6.

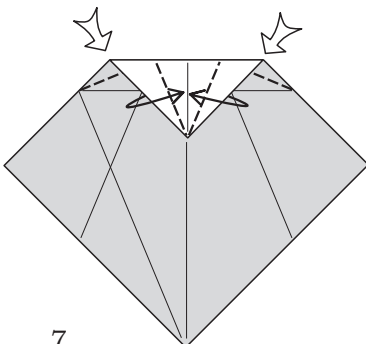

7.

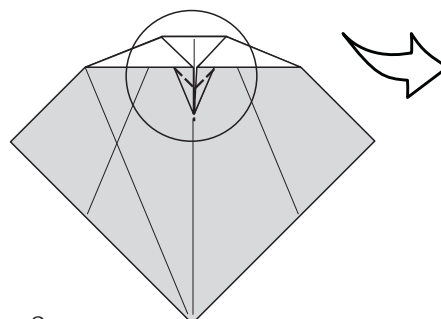

8.

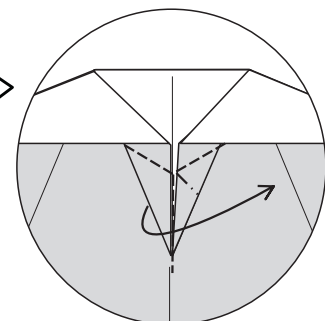

9.

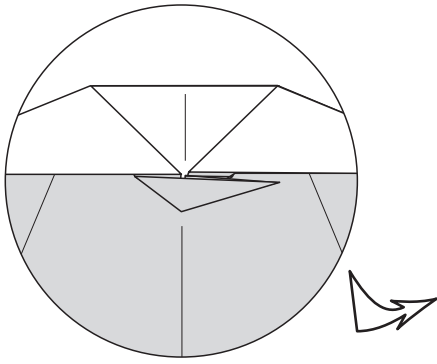

10.

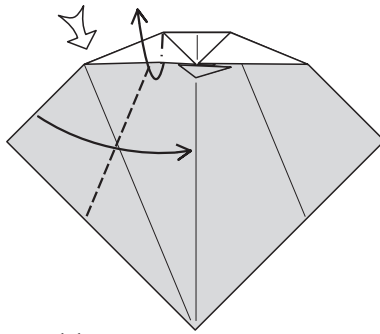

11.

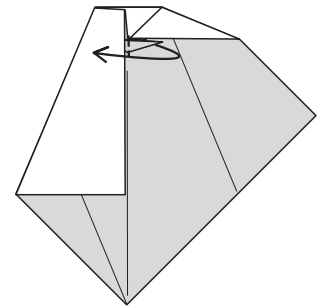

12.

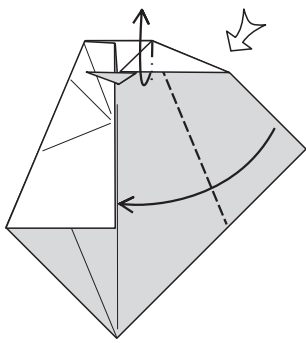

13.

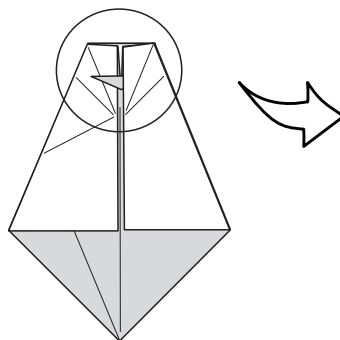

14.

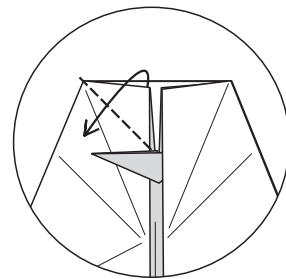

15.

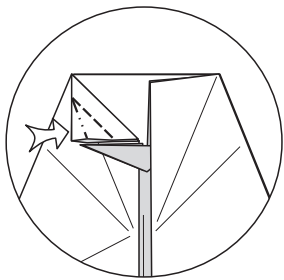

16.

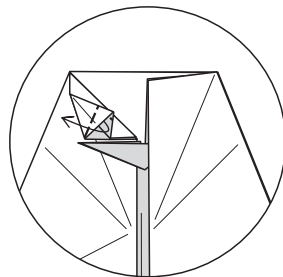

17.

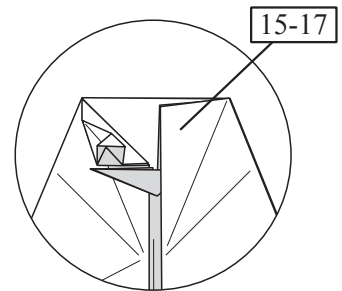

18.

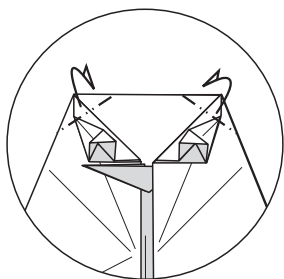

19.

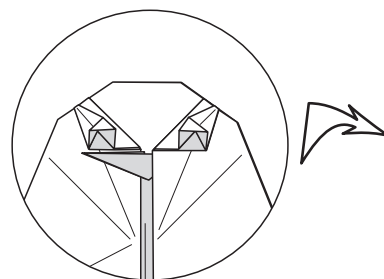

20.

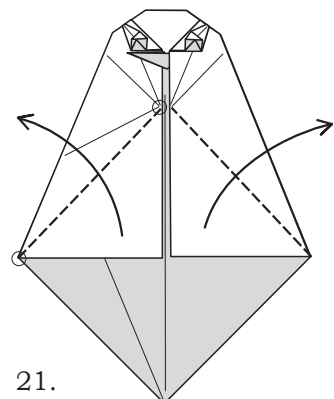

21.

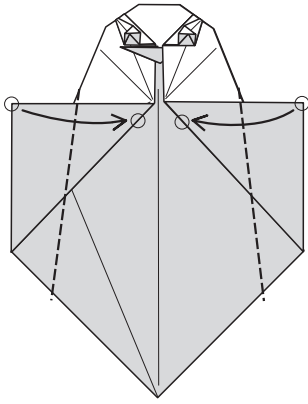

22.

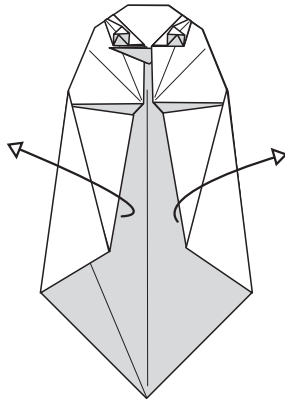

23.

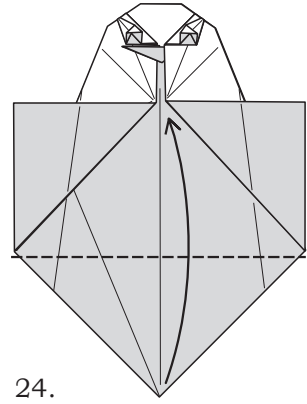

24.

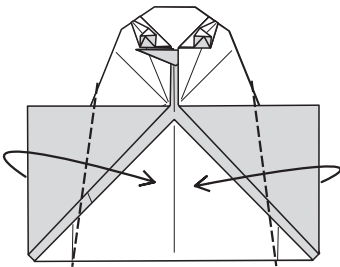

25.

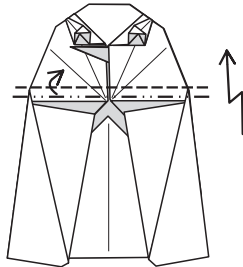

26.

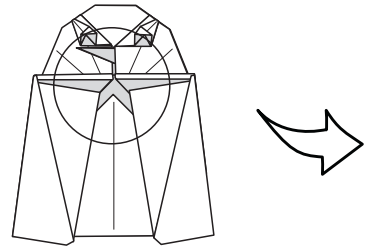

27.

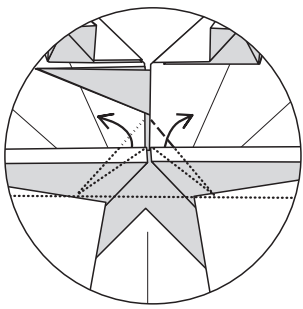

28.

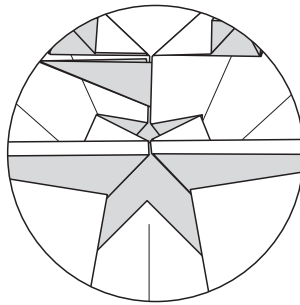

29.

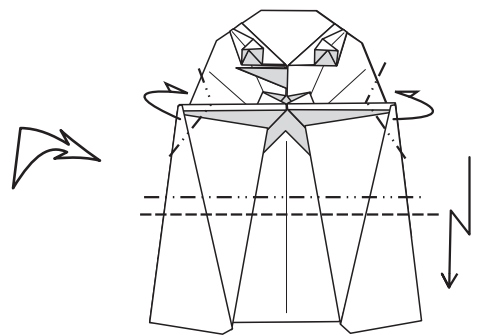

30.

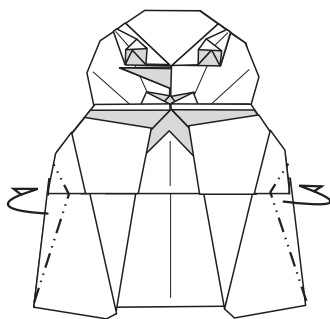

31.

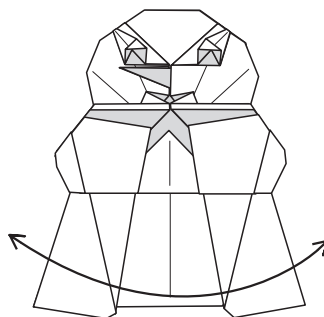

32.

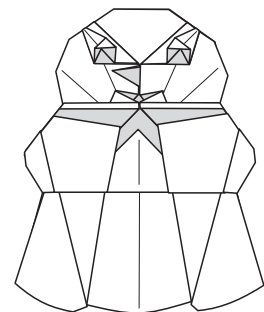

33.

MUÑECO DE NIEVE: versión multicapa
BONHOMME DE NEIGE: multicouche
SNOWMAN: multilayer version

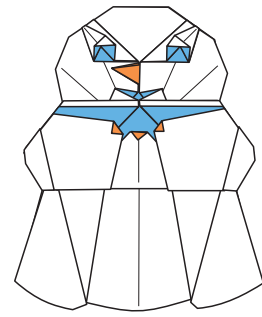

Usando las dos hojas que se muestran comenzar a doblarlas por separado hasta el paso 6.

Using two sheets like the ones shown start folding them separately up to step 6.

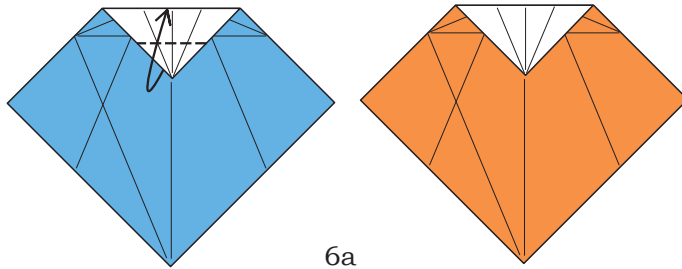
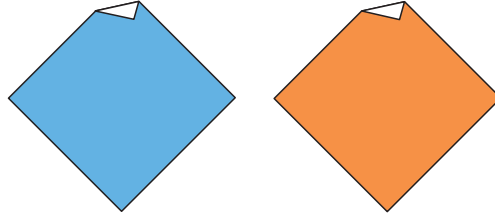

6a

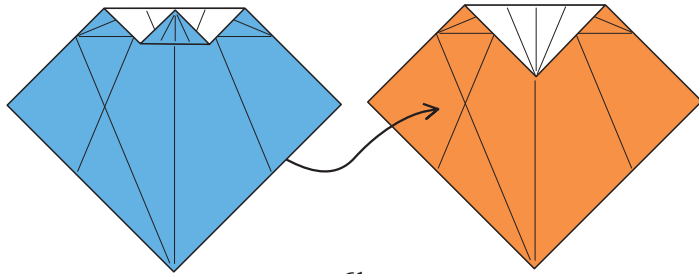

6b

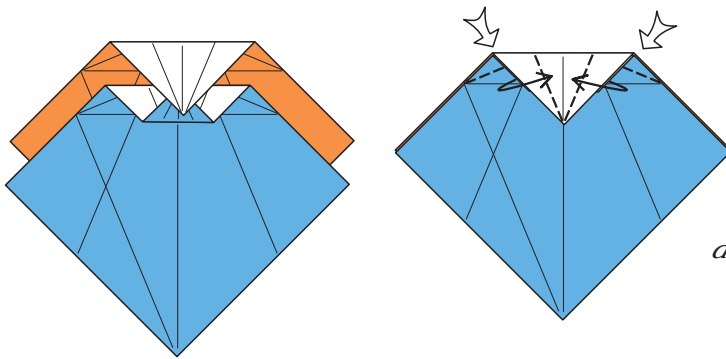

7. Doblar el paso 7 tal como se muestra en el diagrama principal. Seguir doblando normalmente con las dos hojas como si fuesen una.
Fold step 7 like it is shown in the main diagram. Keep folding normally with the two sheets as one.

En las terminaciones utilizar las puntas del papel para hacer adornos en los bordes del cuello.
En the finishing use the original points of the paper to make decorations on the neck area.

